

Year 1 Did you know?

Know more, Remember more

Spring term 2021/22



**Mercenfeld
Primary
School**

Mercenfeld Year 1 Curriculum

This booklet outlines the topics that we will be covering in Year 1 over the Spring term. We hope you find these useful to outline your child's learning.

For each topic area, you will find a 'Did you know?' They will show you the main elements of learning for your child.

Additionally, there is 'key vocabulary' to explore and use in a sentence or during play. These are particularly useful when making links at home about their learning at school.

More information about our curriculum can be found on the school's website.

Bright lights. Big City

Did you know....



Physical features

The landscape of the United Kingdom has many different physical features.



river



flatland



mountain



forest

Landmarks

A landmark is a feature, such as a building, that can be seen from far away. A landmark can help you to describe your location. London has many famous landmarks.



Big Ben



Tower Bridge



London Eye



Buckingham Palace

HM Queen Elizabeth II

Elizabeth II is the monarch of the United Kingdom. She was born in 1926 and became queen in 1952. She was married to Prince Philip and has a large family. She lives in Buckingham Palace in London. The Queen is very important. She visits charities and schools in the United Kingdom and welcomes world leaders to Buckingham Palace.



Tourism

This is where people travel to a place they don't live to look at the sights (tourist attractions).

Settlement

This is a place where people live and work.

Village, Town, City

Capital City

This is a city that is the home of the country's government and ruler.

More about The Queen

Crown Jewels

Queen Elizabeth II wore the Crown Jewels when she was crowned in 1953 at Westminster Abbey.



Image from: Wikimedia Commons/Public Domain

Meeting world leaders

The monarch meets other world leaders. They stay at Buckingham Palace when they visit the United Kingdom.



Image from: Victoria Jones/AP/Getty Images

The monarch's jobs

The monarch has many important jobs. They visit charities and schools and lead special celebrations. They also give out many awards.



Image from: Wikimedia Commons/Public Domain

Royal garden parties

Over 8000 people are invited to a royal garden party that is held three times a year at Buckingham Palace. Guests can explore the garden, enjoy tea and sandwiches and meet the monarch.

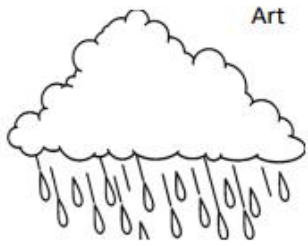

Image from: Thomas Feghli/istock.com

The Great Fire of London



Thomas Farriner was the baker of King Charles II. His bakery shop was on Pudding Lane in London. A spark from one of his ovens started a terrible fire on Sunday 2nd September 1666. It was known as the Great Fire of London.



Art

Rain and Sunrays



Did you know....

Printmaking transferring an image from one place to another.

Collagraphy a way to make a print using a collage and a thin layer of ink.

block	A flat surface, such as cardboard or wood, on which materials are stuck.
collage	A picture made up of different, smaller parts.
equipment	The tools and materials needed for a particular purpose, such as printing.
ink	A coloured gel or solution, used to colour a surface.
method	A way of doing something.
motif	A simple shape or image used for printmaking.
pattern	A design in which lines, shapes or colours are repeated.

Printing equipment

Special equipment is needed to make a collagraph.



printing rollers



printing tray



coloured printing inks



textural materials

Printing motifs

A printing motif is an image made with simple lines and shapes. A motif can be used once in a design, or repeated to make a pattern.



sun motif

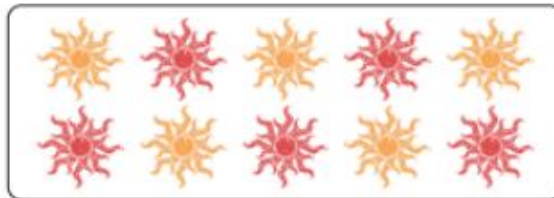

sun motif pattern

Famous artists who have used collagraphy ...

...Pablo Picasso

...Albrecht Dürer

...Hiroshige



Taxi!

Did you know....

Circular object which
turns around and axle.

WHEEL

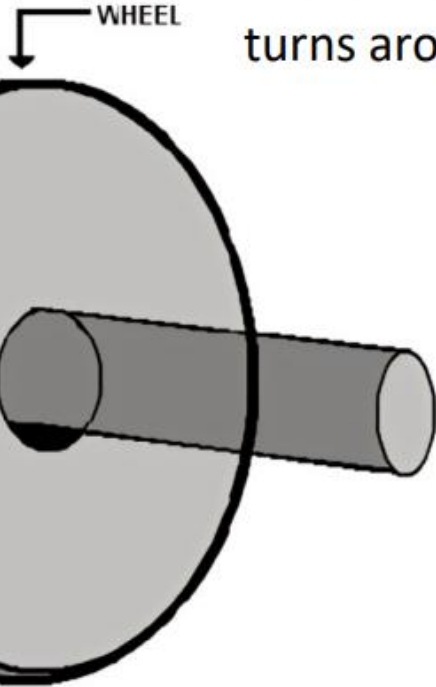

DT

AXLE

Rod that goes
through a
wheel to
support it
spinning.

**Some
more useful
words**

Vehicle...

Something that is used for
transporting things or people.

Design...

Creating a plan for something you
want to make.

Evaluate...

To consider what went well and
what you could make better.



All vehicles have a
chassis. This is the
body of a vehicle such as
a car.

Key Vocabulary

Friendship	Being friends with another person.
qualities	The behaviours that make up a person's character.
humorous	Something or someone that makes you laugh.
trustworthy	Someone you can trust.
respect	To treat someone or something like they matter.
disagreement	A falling out.
advice	Help.
conflict	A serious argument.
united	Working together.
resolve	Sort a problem out.

What makes a good friend?

A good friend may have particular qualities. They might be:

- kind
- humorous
- cheerful
- helpful
- caring
- trustworthy



We might not always agree with our friends but that is okay. We must listen to and **respect** the ideas of others, even if they are not the same as ours.

Falling Out

Sometimes friends might have a **disagreement**, like the lion and the tiger in the story of The Wind and the Moon.



Making Up

The lion and the tiger got some **advice** from a wise man. The man told them to 'live without **conflict** and remain **united**.' When we fall out, we have a choice about how to **resolve** it.

Religious Stories

The Wind and the Moon is a Buddhist story. Buddhism is one of the main world religions. There are lots of religious stories about **friendship**.





Key Vocabulary

Hindu	A follower of Hinduism (one of the main world religions) or something linked to Hinduism.
Christian	A follower of Christianity (one of the main world religions) or something linked to Christianity.
actions	Things that are done.
consequences	The effect of someone's actions.
Bible	The holy book followed by Christians.
Jesus	The son of God.
disciples	Followers of Jesus during his life.
apostles	Early Christian teachers.
tax collector	Someone whose job it is to collect money for the people in charge.

The Deer and the Crow

The Deer and the Crow is a **Hindu** story about **friendship**. In the story, the crow's **actions** help to save his friend. Friends look out for each other.



David and Jonathan is a **Christian** story about **friendship** from the **Bible**. Jonathan helped his friend even though the **consequences** could have been dangerous for him.

Jesus' Disciples

Twelve special **disciples** were chosen to be **apostles**. **Jesus** chose the twelve **disciples** himself. They were ordinary people like fishermen and **tax collectors**. The **disciples** left everything behind to follow **Jesus** and listen to his teaching. The **disciples** were called Simon, James, Andrew, John, Judas, Thaddeus, Peter, Matthew, Thomas, Phillip, Bartholomew and James the Younger. **Jesus** chose these twelve men because they had good **qualities** and they helped him spread his teaching to others.



Seasonal Changes

Adapting

Humans and animals adapt their behaviour to survive during the changing seasons.

Did you know....



Clothing

Clothing worn may change, and the food available might be different during each season.



Hibernate

Spend the cold months being inactive (can be seen as sleeping).

Day and Night

The length of daylight is affected by the change of the seasons.

Rocket to the moon

Computer	Electronic machine that accepts and processes information to produce an output, and then stores the results.
Computer program	A series of instructions, that are written for a computer to follow. Also known as apps.
Create	To make something.
Data	Information used for a specific purpose or investigation.
Digital content	Information and media such as videos and pictures stored on a computer.
e-Document	An electronic file which includes text.
Folder	An electronic storage file that holds other digital content for example text, pictures, videos.
List	A number of things, one after the other.
Save	To store something for use later.
Sequence	A set order or pattern for something to follow.
Share	To show or give a part of something to someone else.
Spreadsheet	An electronic document that lets you store data in rows and columns.

Key facts



My computer

Mountains.jpg My documents Rocket materials.txt My homework

Writing program - Rocket materials.txt

File Save Print Copy Cut Font Clipart

A list of bottle rocket materials:

1. Empty plastic bottle
2. Roll of sticky tape
3. Sugar paper or coloured card

How to make a bottle rocket:



1. Collect the materials

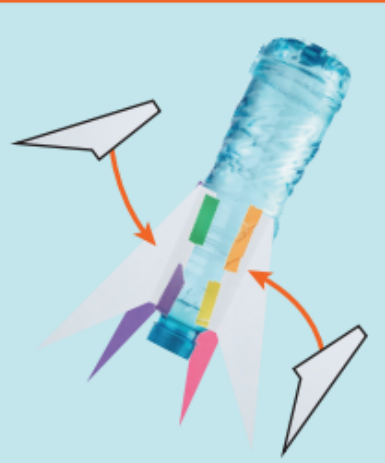

2. Cut and add the fins

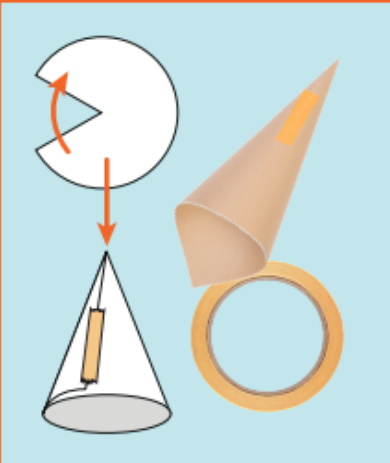

3. Make the nose cone

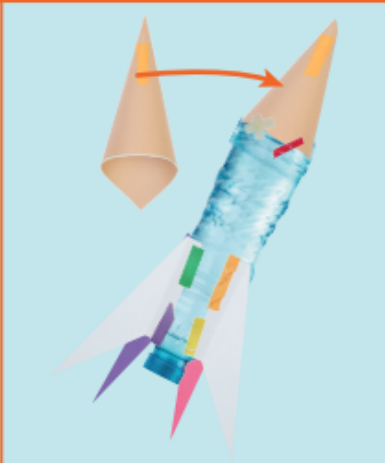

4. Attach the nose cone

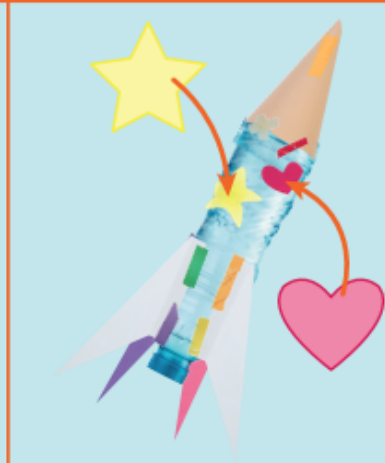

5. Decorate the rocket

Programming - Bee Bot

Algorithm	A clear set of instructions to carry out a task.
Bee-Bot	A small programmable floor robot, with seven buttons (forwards, backwards, turn right, turn left, go, pause and clear).
Computing code	Words, numbers and symbols that make a computer language.
Computer program	A series of instructions, that are written for a computer to follow. Also known as apps.
Explain	Give clear information about something to someone.
Explore	Look at something new to learn more about it.
Instructions	A list of commands and directions on how to do something.
Predict	To make a guess.
Tinker	To explore and play with something to discover what it can do.
Video	Moving pictures, that make up a film or cartoon.

Key facts

